

USER MANUAL

Type FPT-000-0050

57333 12/06 - (BJ)



Introduction

The thermostat is capable of switching on your heating system at pre determined times on different days of the week. It is possible to set 4 periods called events each day with different temperatures. From factory a default schedule is programmed suitable for most installations. Unless you change these settings the thermostat will operate to this default program.

Working with lower temperatures during times that the room is unoccupied will lower your energy costs without reducing the comfort. The thermostat has an adaptive function that automatically changes the start time of a heating period so that the desired temperature is reached at the time that you set. After 3 days the adaptive function has learned when the heating must be switched on.

The thermostat has a built-in temperature sensor and an externally temperature sensor. In this configuration the thermostat controls the temperature within the room and use the externally temperature sensor as limit sensor avoiding too high or too low temperatures in the floor construction.

The thermostat has a pin button marked R, allowing you to reset the thermostat to factory settings. These are listed at the end of this manual with space for you to record your own weekly schedule.

The display is backlit when operating the buttons. The heating element is switched off when the light is on in the display.

The heating system can be switched off on the built-in interrupter. The Microprocessor taking care of the time will still be supplied with power whereby time and day will be maintained. When the heating is required and the thermostat is switched on, it will continue the 4-event programme based on present time and day.

1. Getting started

Buttons

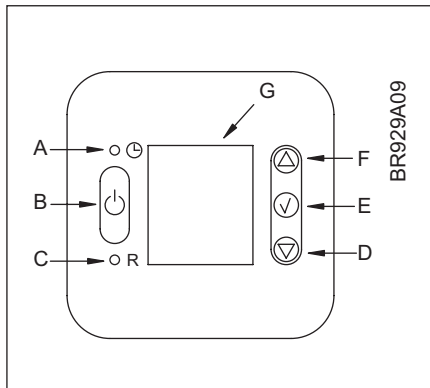

| | | | |
|----------------------------|--------|--------------------------|-----------------|
| A: | B: | C: | D: |
| Pin button adjust of clock | On/off | Reset to factory setting | Adjustment down |

| | | |
|-------------|---------------|---------|
| E: | F: | G: |
| OK - accept | Adjustment up | Display |

Display symbols

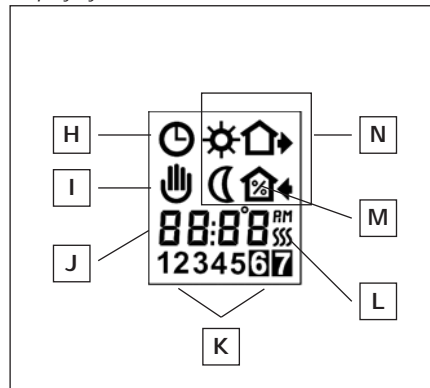

| | | | |
|----------------|-------------|----------------------|------------|
| H: | I: | J: | K: |
| Clock function | Manual mode | Time and temperature | Day number |

| | | |
|------------|--------------------------------|--|
| L: | M: | N: |
| Heating on | % Monitoring of switch-on time | 4-event symbol Wake Out Night Home |

Setting the thermostat into operation

First time power is connected the clock and day will be flashing and must be set. If you need to adjust the time of the thermostat at a later date, insert a pin into the hole for setting of time and day. Adjustment must be made for summer and winter time.

| | | | |
|--|--|--|-----|
| | | Press the UP () or DOWN () buttons to select the correct time and press OK button () . | |
| | | Then press the UP () or DOWN () button to select the correct day and press OK () button. | 1-7 |

2. Daily use of the thermostat
4-event clock mode

The day has been split into 4 events describing a typical day. When the thermostat is in 4-event mode it will automatically adjust the temperature according to the required temperature to the required time. As standard the thermostat has 5 days with 4 events, and 2 days with 2 events. Programming see 3.

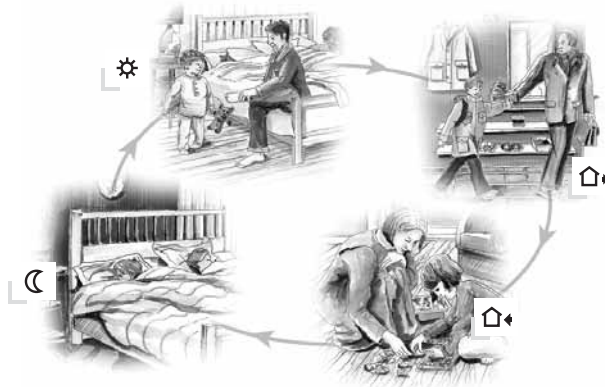

| | | |
|-------------------------------------|--|--|
| 4-event clock mode: | | The clock function symbol (🕒) and one of the 4-event symbols (☀️ 🏠👉 🌙 🏠👈) will be indicated. Programming see 3. |
| Comfort mode: 👉 ⬆️ ⬇️ ⏳ 5 secs. | | Temporary override To temporarily override the temperature in the 4-event schedule program, press the UP (⬆️) or DOWN (⬇️) button once, to show the temperature, and press again to increase or decrease the temperature. The display will flash for 5 seconds, and will then revert to the time. The override will operate until the next programmed event when the unit will resume the automatic programme. |
| 👉 ✓ ✓ | | Cancel comfort mode To cancel the override state, press the OK (✓) button twice. |
| Manual mode: 👉 ✓ ⬆️ ⬇️ ⏳ 5 secs. | | Permanent override: During holidays, the scheduled 4-event program can be overridden. Press the OK (✓) button, and then the UP (⬆️) or DOWN (⬇️) button until the override temperature is set. The unit will now operate to this temperature permanently. |
| 👉 ✓ | | Cancel manual mode To cancel the permanent override state press the OK (✓) button once, and the unit will resume automatic function. |

3. Programming
4-event time and temperature

For each event, the start time and required temperature must be set.

For example, in the morning you wish the heating to start at 07:00 and the temperature to rise to 21°C. Press OK (✓) button for 3 seconds and the start time is displayed. Change this to 07:00 with the UP (⬆️) or DOWN (⬇️) button. Press OK (✓) to confirm. The temperature is now displayed. Change this to 21°C with the UP (⬆️) or DOWN (⬇️) button. Press OK (✓) button to confirm. This action can now be repeated for the second event.







These settings will be valid with days 1-5 showing on the display. To program the days 6 and 7, repeat the above. Days 6 and 7 are usually Saturday and Sunday, and only have two events.

The temperature can be set within the range of +5 to +40°C. It is also possible to select the heating OFF at that event by reducing the setting to 5°C, and then pressing the (⬇️) once more.

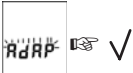
| | | |
|--|-----------|--|
| Press OK (✓) button for 3 secs. to begin programming | | |
| Day 1 - 5 | | |
| | 👉 ⬆️ ⬇️ ✓ | |
| | 👉 ⬆️ ⬇️ ✓ | |
| | 👉 ⬆️ ⬇️ ✓ | |
| | 👉 ⬆️ ⬇️ ✓ | |
| | 👉 ⬆️ ⬇️ ✓ | |
| | 👉 ⬆️ ⬇️ ✓ | |
| Day 6 - 7 | | |
| | 👉 ⬆️ ⬇️ ✓ | |
| | 👉 ⬆️ ⬇️ ✓ | |

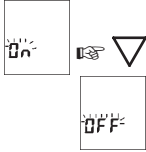
4. Advanced settings and read-out

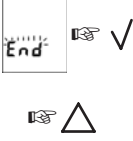
| | |
|--|---|
| | <p>Press both UP (Δ) and DOWN (∇) buttons together for 3 seconds. INFO is displayed. Press UP(Δ) button until you reach the desired sub menu. Select the sub menu with the OK (✓) button.</p> |
| | <p>Monitoring of energy consumption The thermostat calculates average time it has been switched on allowing you to monitor your energy consumption. In the thermostat you can read out: Total switch-on time in percentage in the latest 2 days, 30 days or 365 days. Calculation of operational costs per day: (switch-on time:100) x kW x kWh-price x 24 h per day Example: Read-out: 30 % in the latest 365 days Size of heating system: 1,2 kW (ask the installer) Cost of power: 0,2 EUR / kWh Calculation: (30:100) x 1,2 kW x 0,2 EUR / kWh x 24 h = 1,7 EUR per day</p> <div style="display: flex; justify-content: space-between;"> <div data-bbox="244 414 877 696"> <p>2 days 30 days 365 days Software version Regulation sensor Limit sensor (visible if configured as OCD2)</p> </div> <div data-bbox="885 414 1463 696"> <p>Press UP (Δ) or DOWN (∇) button to show the different readouts. No changes can be made here. Use the OK (✓) button to end.</p> </div> </div> |
| | <p>4-event sequence The present event sequence flashes: Days 1-5, followed by days 6-7. To change, press the UP (Δ) button until you have days 1-6 and then day 7 flashing, or all 7 days are flashing. Select the required sequence with the OK (✓) button.</p> <div style="display: flex; justify-content: space-between;"> <div data-bbox="244 797 877 1032"> </div> <div data-bbox="885 797 1463 1032"> <p>5-2: 4 events in 5 days + 2 events in 2 days. 6-1: 4 events in 6 days + 2 events in 1 day 7-0: 4 events in 7 days</p> </div> </div> |
| | <p>Selection of type roLi : As standard the thermostat controls the temperature within the room and use the externally temperature sensor as limit sensor avoiding to high or to low temperatures in the floor. FLo : In this application the thermostat controls the temperature of the floor and not the temperature within the room. ro : In this application the thermostat controls the temperature of the room and the external temperature sensor should not be installed.</p> <div style="display: flex; justify-content: space-between;"> <div data-bbox="244 1211 877 1447"> </div> <div data-bbox="885 1211 1463 1447"> <p>roLi : Room temperature control with floor limitation sensor FLo : Floor temperature control ro : Room temperature control</p> </div> </div> |
| | <p>Max and min allowed temperature range. The temperature setting range of +5° to +40°C can be limited to prevent a too high or too low temperature being selected under manual or comfort mode. For application with limit sensor the max. and min. temperature range refer to the temperature of the limit sensor. For example: A wood floor covering should not be allowed to exceed a maximum of 27°C. Low limitation is used where the temperature of the floor is required never to fall below the minimum set temperature.</p> <div style="display: flex; justify-content: space-between;"> <div data-bbox="244 1570 877 1805"> </div> <div data-bbox="885 1570 1463 1805"> <p>Maximum allowed temperature setting. Use the UP (Δ) or DOWN (∇) button to increase or reduce, and OK (✓) button to accept. Next is displayed LoLi. Press OK (✓) button to continue. Minimum allowed temperature setting. Use the UP (Δ) or DOWN (∇) button to increase or reduce and OK (✓) button to accept.</p> </div> </div> |
| | <p>Time and temperature scale selection</p> <div style="display: flex; justify-content: space-between;"> <div data-bbox="244 1861 877 2045"> </div> <div data-bbox="885 1861 1463 2045"> <p>You can select either °C or °F scale, and 12 or 24 hour clock as follows: Press UP (Δ) or DOWN (∇) button to change settings. Confirm the required scale with the OK button (✓) button.</p> </div> </div> |

| | |
|---|--|
|  | <p>Adaptive function: This function enables the thermostat to calculate when it needs to switch ON so that the required temperature is reached at the set time. With a start time of 07:00 therefore, the thermostat may switch ON as early as 06:00 so that the desired temperature of 25°C is achieved by 07:00. Without this function set, the thermostat will start to heat at the time you set.</p> |
|  | <div style="display: flex; align-items: center; justify-content: space-around;"> <div style="text-align: center;">  </div> <div style="font-size: 2em;">}</div> <div style="text-align: center;">  </div> <div style="text-align: center;">  </div> </div> <p>Press the DOWN (▽) button to switch between on and off. Press OK (✓) button to confirm.</p> |
|  | <div style="text-align: center;">  </div> <p>Press OK (✓) button to end programming and to return to scheduled programme.</p> |

5. Reset to factory setting

| | |
|---|--|
|  | <p>Press the pin button for 3 secs. and the thermostat returns to factory settings. Time and day is also reset and must be set according to "Setting the thermostat into operation". Note that a OCD2 that has been modified to a OCC2 (see 4. Advanced settings and read-out, selection of type) will return to a OCD2. Failure code E2 will be displayed if the external sensor has been removed.</p> |
|---|--|

Factory settings

| 4-event time and temperature | | | | |
|------------------------------|-------------|--|-------------|--|
| Day 1-5 | Time | | Temperature | |
| ☀ | 06:00 | | 20°C | |
| 🏠➡ | 08:00 | | 15°C | |
| 🏠➡ | 16:00 | | 22°C | |
| ☾ | 22:30 | | 15°C | |
| Day 6-7 | | | | |
| ☀ | 08:00 | | 22°C | |
| ☾ | 23:00 | | 15°C | |
| 4-event sequence | 5:2 | | | |
| Hi-Low temp. | 28°C / 15°C | | | |
| Scale | 24 H / °C | | | |
| Adaptive control | ON | | | |

6. Failure codes

- E0 = Internal failure, replace thermostat
- E1 = Built-in sensor short-circuit or disconnected, replace thermostat
- E2 = External sensor short-circuit or disconnected



www.floorheating4u.co.uk
info@floorheating4u.co.uk

OJ ELECTRONICS A/S
Stenager 13B · DK-6400 Sønderborg
oj@oj.dk · www.oj.dk

